

PULPITY INFORMACYJNE –
KOLORYSTYKA

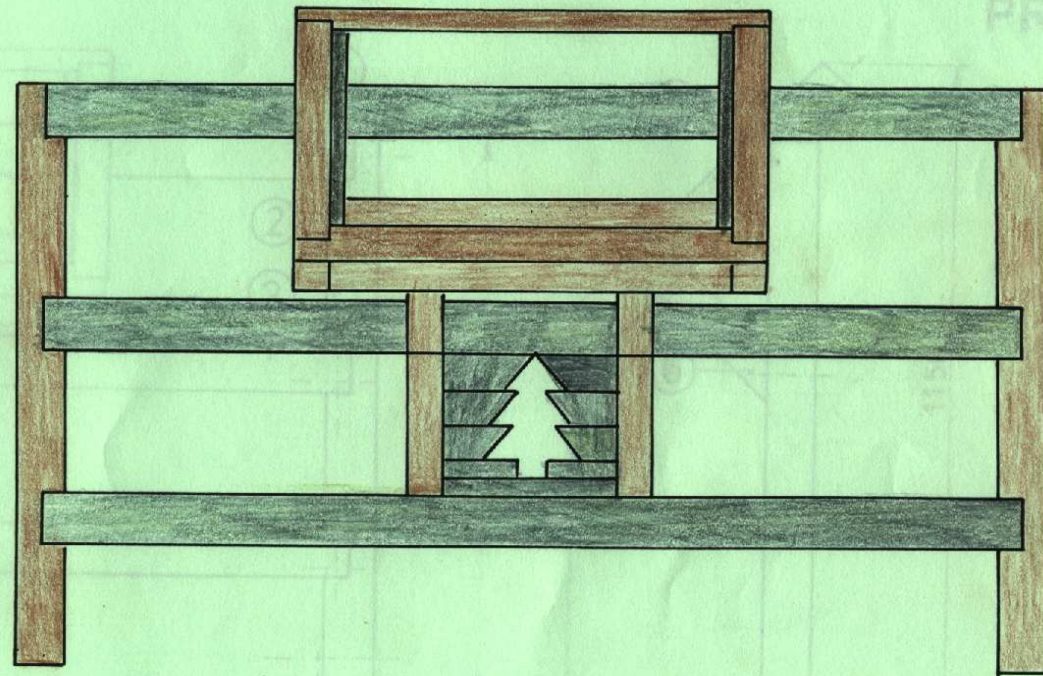

PRZEKRÓJ A-A

WIDOK Z PRAWY

WIDOK Z BOKU

WIDOK Z GÓRY

6.1

PULPITY INFORMACYJNE -WIDOKI

PULPITY INFOR...
-CZĘŚCI SKŁADOWE

PRZEKRÓJ A-A

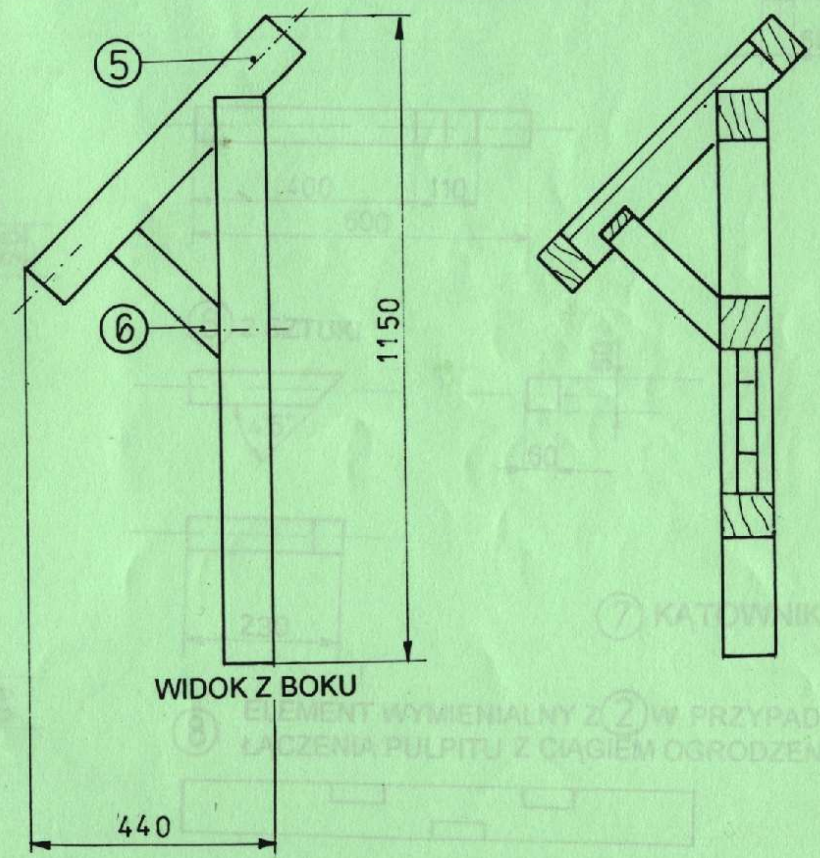
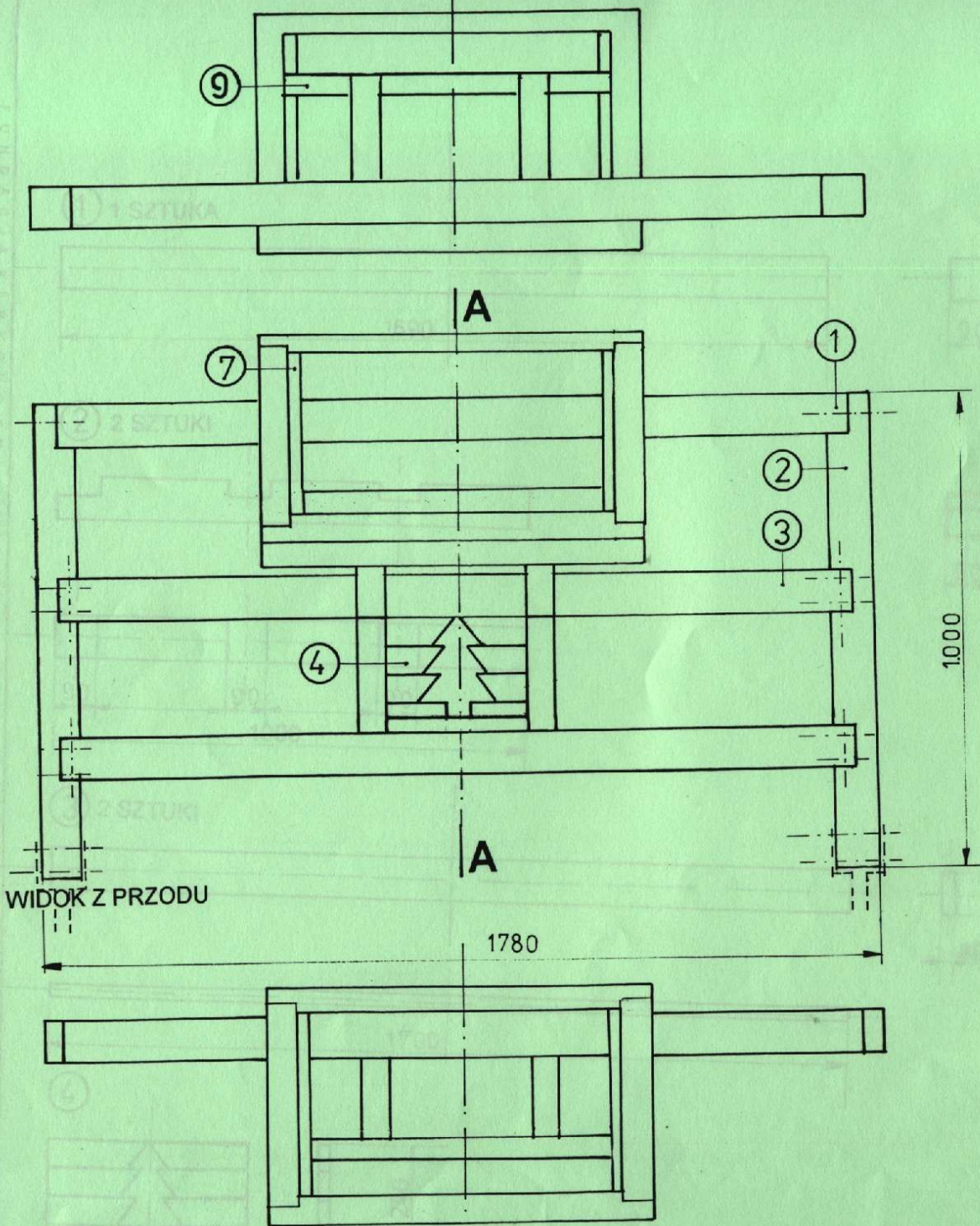

7 KATODNIK

8 ELEMENT WYMIENIALNY Z 2 W PRZYPADKU
ŁĄCZENIA PULPITU Z CIĄGIEM OGRODZENIA

SKALA 1:10

FUNDACJA KARKONOSKA 1998 DAGMARA JAŚNIAK IZABELA KONKA DOMINIKA KORZEN
SYSTEM INFORMACJI WIZUALNEJ JAKO ELEMENT EDUKACJI EKOLOGICZNEJ

PULPITY INFORMACYJNE - CZĘŚCI SKŁADOWE

① 1 SZTUKA

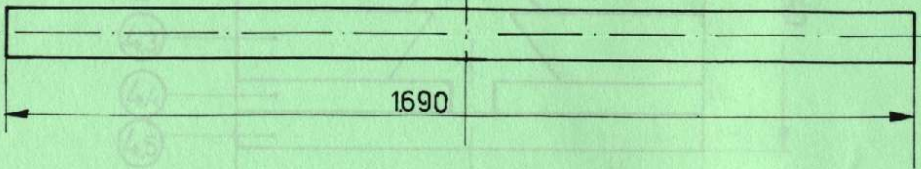

② 2 SZTUKI

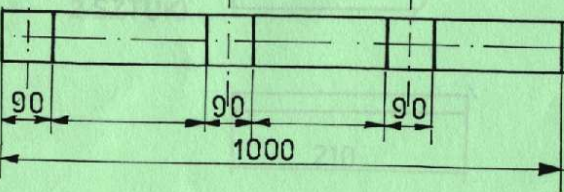
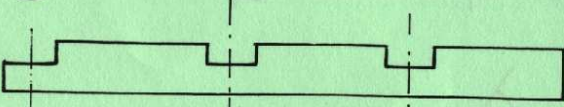

③ 2 SZTUKI

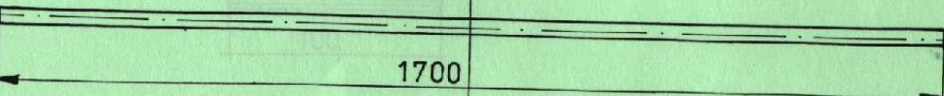
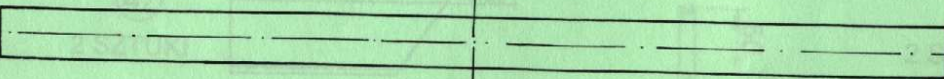

④

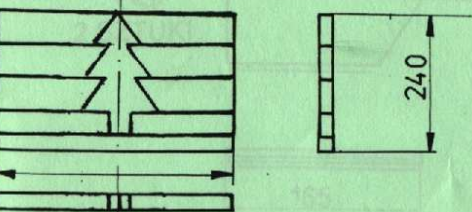

⑨

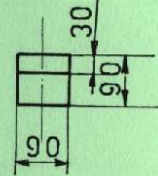
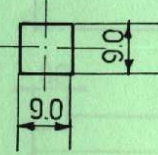

⑤ 2 SZTUKI

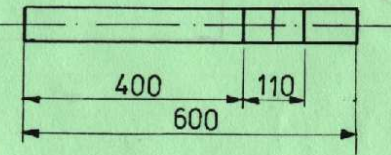
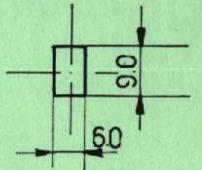
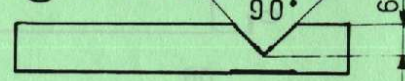

⑥ 2 SZTUKI

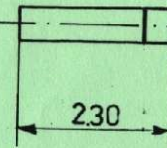
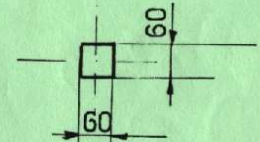
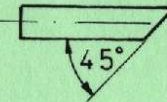

⑦ KĄTOWNIK

⑧ ELEMENT WYMIENIALNY Z ② W PRZYPADKU
ŁĄCZENIA PULPITU Z CIĄGIEM OGRODZENIA

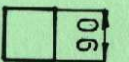
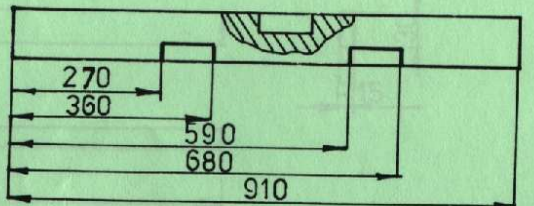
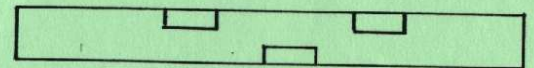

SKALA 1:10

PULPITY INFORMACYJNE

-POWIĄZANIE
Z OGRÓDZENIEM
-DETAL

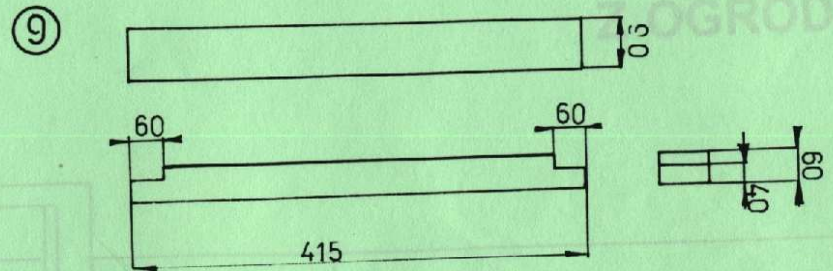
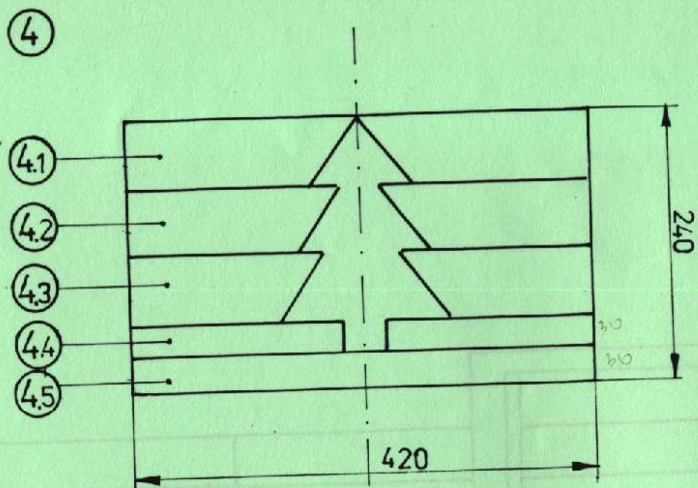

④.1
2 SZTUKI

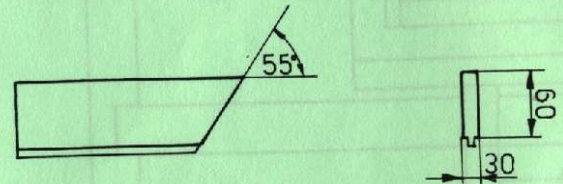

④.2
2 SZTUKI

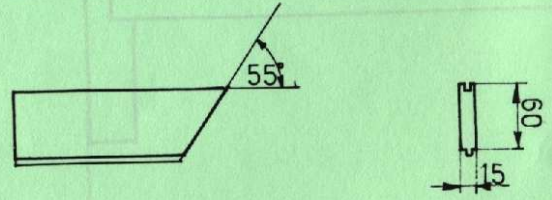
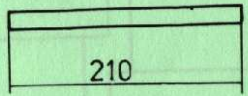

④.4
2 SZTUKI

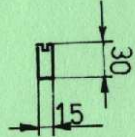
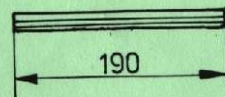
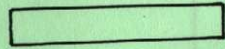

④.3
2 SZTUKI

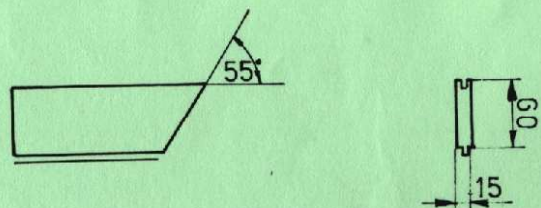
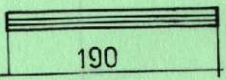

④.5
1 SZTUKA

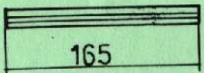
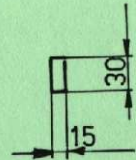
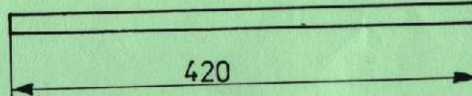
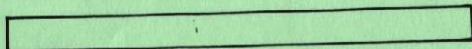

SKALA 1:5

FUNDACJA KARKONOSKA 1998 DĄGMARA JAŚNIAK IZABELA KONKA DOMINIKA KORZEN
 SYSTEM INFORMACJI WIZUALNEJ JAKO ELEMENT EDUKACJI EKOLOGICZNEJ